

Induktiver Näherungsschalter
Détecteur de proximité inductif
Inductive Proximity Switch



DW - A□ - 519 - M30

Durchmesser Diamètre Diameter	M30	Schaltabstand Portée Operating distance	0...40mm	Einbau Montage Mounting	nicht bündig non noyable non-embeddable
-------------------------------------	------------	---	-----------------	-------------------------------	--

Ausführung mit Analogausgang

Appareil à sortie analogique

Analog output model

Wichtigste Eigenschaften:

- Erfassungsbereich 0 ... 40 mm
- Betriebsspannung 10...30 VDC
- Spannungsausgang 0 ... 5 V
- Stromausgang 1 ... 5 mA
- Kurzschlusschutz, Induktionschutz, Verpolungsschutz eingebaut
- Nicht linearisierte Ausführung
- Anschluss über Kabel oder Stecker S12

Caractéristiques principales:

- Domaine de détection 0 à 40 mm
- Tension de service 10 ... 30 VDC
- Tension de sortie 0 à 5 V
- Courant de sortie 1 à 5 mA
- Protections contre les courts-circuits, les surtensions induites et l'inversion de tension incorporées
- Version non linéarisée
- Raccordement par câble ou par connecteur S12

Main features:

- Sensing range 0 to 40 mm
- Supply voltage 10 ... 30 VDC
- Output voltage 0 to 5 V
- Output current 1 to 5 mA
- Protections against short-circuits, induced overvoltages and power supply reversal built-in
- Non-linearized version
- Cable and S12 connector versions

Technische Daten

(gemäss IEC 60947-5-2)

Caractéristiques techniques:

(selon CEI 60947-5-2)

Technical data:

(according to IEC 60947-5-2)

Erfassungsbereich s_d	Domaine de détection s_d	Sensing range s_d	0 ... 40 mm
Normmessplatte	Cible normalisée	Standard target	120 x 120 x 1 mm
Wiederholgenauigkeit (gemäss IEC 60947-5-2)	Reproductibilité (selon CEI 60947-5-2)	Repeat accuracy (according to IEC 60947-5-2)	0,6 mm ($U_B = 20 \dots 30$ VDC, $T_A = 23 \text{ °C} \pm 5 \text{ °C}$)
Wiederholgenauigkeit ($T_A = \text{konstant}$)	Reproductibilité ($T_A = \text{konstant}$)	Repeat accuracy ($T_A = \text{konstant}$)	$\pm 0,1$ mm
Auflösung	Résolution	Resolution	$\leq 10 \mu\text{m}$
Betriebsspannungsbereich U_B	Tension de service U_B	Supply voltage range U_B	10 ... 30 VDC
Zulässige Restwelligkeit	Ondulation admissible	Max. ripple content	$\leq 20\% U_B$
Ausgangsspannung an A1 $s = 0$ mm	Tension de sortie à A1 $s = 0$ mm	Output voltage at A1 $s = 0$ mm	0 V / - 0 + 0,2 V (23 °C)
$s = 20$ mm	$s = 20$ mm	$s = 20$ mm	+ 2,6 V / $\pm 0,2$ V (23 °C)
$s = 40$ mm	$s = 40$ mm	$s = 40$ mm	+ 5 V / $\pm 0,2$ V (23 °C)
Laststrom am Spannungsausgang A1	Charge à la sortie tension A1	Load at voltage output A1	≤ 10 mA
Ausgangsstrom an A2 $s = 0$ mm	Courant de sortie à A2 $s = 0$ mm	Output current at A2 $s = 0$ mm	1 mA / $\pm 0,2$ mA (23 °C)
$s = 40$ mm	$s = 40$ mm	$s = 40$ mm	5 mA / $\pm 0,2$ mA (23 °C)
Max. Last am Stromausgang A2	Charge max. à la sortie courant A2	Max. load at current output A2	1 k Ω ($U_B=10$ V) / 5 k Ω ($U_B=30$ V)
Leerlaufstrom	Courant hors-charge	No-load supply current	≤ 10 mA
Bandbreite	Bande passante	Bandwidth	100 Hz (-3 dB bei / à / at $s=20$ mm)
Bereitschaftsverzögerung	Retard à la disponibilité	Time delay before availability	≤ 50 msec
Umgebungstemperaturbereich T_A	Plage de température ambiante T_A	Ambient temperature range T_A	-25 ... + 70 °C
Temperaturdrift von s_r	Dérive en température de s_r	Temperature drift of s_r	$\leq 10\%$
Kurzschlusschutz	Protection contre les courts-circuits	Short-circuit protection	eingebaut / intégrée / built-in
Verpolungsschutz	Protection contre les inversions	Induction protection	eingebaut / intégrée / built-in
Schocks und Schwingungen	Chocs et vibrations	Shocks and vibration	IEC 60947-5-2 / 7.4
Leitungslänge	Longueur du câble	Cable length	300 m max.
Gewicht (Kabel / Stecker)	Poids (câble / connecteur)	Weight (cable / connector)	215g; 190 g (-120)/ 155g / 135g (-120)
Schutzart	Indice de protection	Degree of protection	IP 67
EMV - Schutz:	Protection CEM:	EMC protection:	
IEC 60255-5	CEI 60255-5	IEC 60255-5	5 kV
IEC 61000-4-2	CEI 61000-4-2	IEC 61000-4-2	Level 2
IEC 61000-4-3	CEI 61000-4-3	IEC 61000-4-3	Level 3
IEC 61000-4-4	CEI 61000-4-4	IEC 61000-4-4	Level 2
Gehäusematerial	Matériau du boîtier	Housing material	Messing cr/laiton cr/cr-plated brass
Aktive Fläche	Face sensible	Sensing face	PBTP
Anschlusskabel (andere Längen auf Anfrage)	Câble de raccordement (autres longueurs sur demande)	Connection cable (other lengths on request)	PUR 4x0,25mm ² / 128 x 0,05mm \varnothing 2m

Anschlussschema

Schéma de raccordement
Wiring diagram

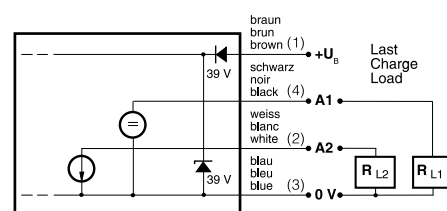

Steckerbelegung (Gerät)
Attribution des pins (appareil)
Pin assignment (device)

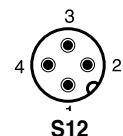

Abmessungen / Dimensions / Dimensions:

Diese Zeichnungen lassen sich aus dem Internet (www.contrinex.com) herunterladen.
Ces dessins peuvent être téléchargés depuis Internet (www.contrinex.com).
These drawings can be downloaded from Internet (www.contrinex.com).

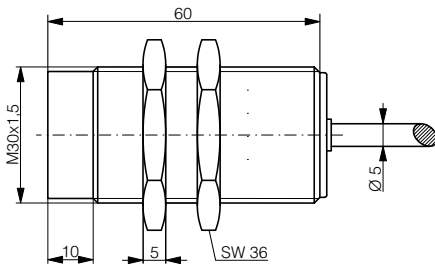

DW-AD-519-M30

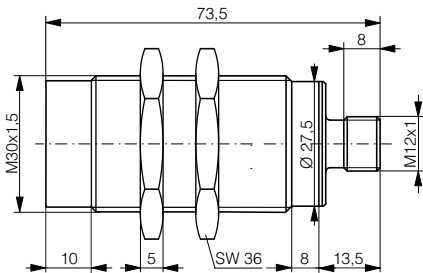

DW-AS-519-M30-002

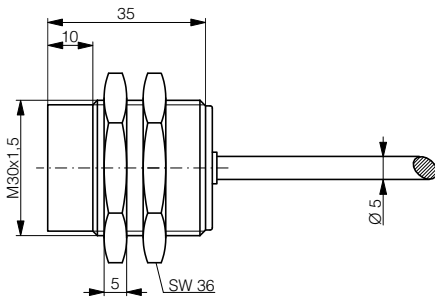

DW-AD-519-M30-120

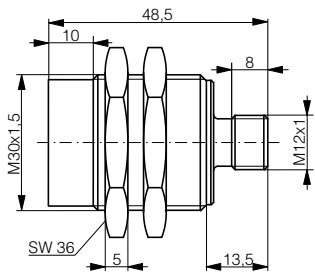

DW-AS-519-M30-120

* typische Werte / valeurs typiques / typical values

Ansprechkurve* / Courbe de réponse* / Response diagram*:

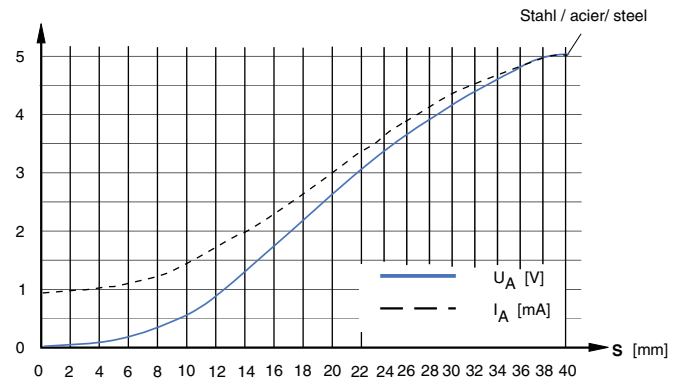

Einbau / Montage / Installation:

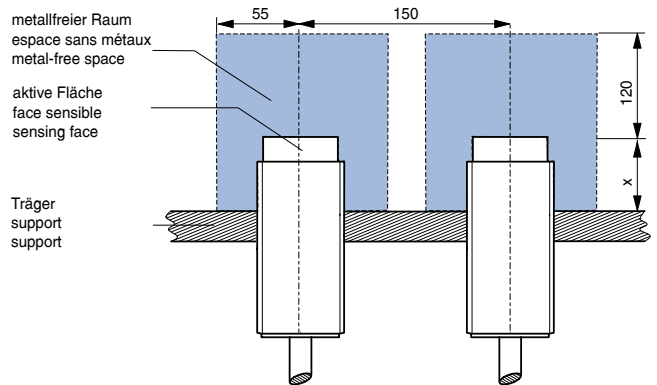

Träger / support / support	x
Aluminium / aluminium / aluminum	25 mm
Stahl / acier / steel	35 mm
Messing / laiton / brass	25 mm
Edelstahl / acier INOX / stainless steel	20 mm

Reduktionsfaktoren* / Coefficients de réduction* / Correction factors*

Stahl FE 360	1,0	Kupfer	0,4	Aluminium	0,4	Messing	0,5	Edelstahl V2A	0,8
Acier FE 360		cuivre		aluminium		laiton		acier INOX V2A	
Steel FE 360		copper		aluminum		brass		stainless steel V2A	

Typenspektrum / Types disponibles / Available types:

Artikelnummer	Typenbezeichnung	Anschluss	Ausgang
Numéro article	désignation	raccordement	sortie
Part number	part reference	connection	output
320 020 133	DW-AD-519-M30	Kabel / câble / cable	Spannung und Strom / tension et courant / voltage and current
320 020 134	DW-AS-519-M30-002	Stecker / connecteur / connector S12	Spannung und Strom / tension et courant / voltage and current
320 020 135	DW-AD-519-M30-120	Kabel / câble / cable	Spannung und Strom / tension et courant / voltage and current
320 020 136	DW-AS-519-M30-120	Stecker / connecteur / connector S12	Spannung und Strom / tension et courant / voltage and current

Der Einsatz dieser Geräte in Anwendungen, wo die **Sicherheit von Personen** von deren Funktion abhängt, ist **unzulässig**. Änderungen und Liefermöglichkeiten vorbehalten. Ces détecteurs **ne peuvent être utilisés** dans des applications où la **protection** ou la **sécurité de personnes** est concernée. Sous réserve de modifications et de possibilités de livraison. These proximity switches **must not be used** in applications where the **safety of people** is dependent on their functioning. Terms of delivery and rights to change design reserved.

Induktiver Näherungsschalter
Détecteur de proximité inductif
Inductive Proximity Switch

DW - A□ - 519 - M30 - 3□□



Durchmesser Diamètre Diameter	M30	Schaltabstand Portée Operating distance	0...40mm	Einbau Montage Mounting	nicht bündig non noyable non-embeddable
-------------------------------------	------------	---	-----------------	-------------------------------	--

Ausführung mit Analogausgang

Wichtigste Eigenschaften:

- Erfassungsbereich 0 ... 40 mm
- Betriebsspannung 15...30 VDC
- Spannungsausgang 0 ... 10 V
- Stromausgang 4 ... 20 mA
- Kurzschlusschutz, Induktionschutz, Verpolungsschutz eingebaut
- Nicht linearisierte Ausführung
- Anschluss über Kabel oder Stecker S12

Appareil à sortie analogique

Caractéristiques principales:

- Domaine de détection 0 à 40 mm
- Tension de service 15 ... 30 VDC
- Tension de sortie 0 à 10 V
- Courant de sortie 4 à 20 mA
- Protections contre les courts-circuits, les surtensions induites et l'inversion de tension incorporées
- Version non linéarisée
- Raccordement par câble ou par connecteur S12

Analog output model

Main features:

- Sensing range 0 to 40 mm
- Supply voltage 15 ... 30 VDC
- Output voltage 0 to 10 V
- Output current 4 to 20 mA
- Protections against short-circuits, induced overvoltages and power supply reversal built-in
- Non-linearized version
- Cable and S12 connector versions

Technische Daten:

(gemäss IEC 60947-5-2)

Erfassungsbereich s_d	Normmessplatte	Wiederholgenauigkeit (gemäss IEC 60947-5-2)	Wiederholgenauigkeit ($T_A = \text{konstant}$)	Auflösung	Betriebsspannungsbereich U_B	Zulässige Restwelligkeit	Ausgangsspannung an A1 $s = 0 \text{ mm}$ $s = 20 \text{ mm}$ $s = 40 \text{ mm}$	Laststrom am Spannungsausgang A1	Ausgangsstrom an A2 $s = 0 \text{ mm}$ $s = 40 \text{ mm}$	Max. Last am Stromausgang A2	Leerlaufstrom	Bandbreite	Bereitschaftsverzögerung	Umgebungstemperaturbereich T_A : A1 belastet, A2 unbelastet A1 unbelastet, A2 belastet	Temperaturdrift von s_r	Kurzschlusschutz	Verpolungsschutz	Schocks und Schwingungen	Leitungslänge	Gewicht (Kabel / Stecker)	Schutzart	EMV - Schutz: IEC 60255-5 IEC 61000-4-2 IEC 61000-4-3 IEC 61000-4-4	Gehäusematerial	Aktive Fläche	Anschlusskabel (andere Längen auf Anfrage)
-------------------------	----------------	---	--	-----------	--------------------------------	--------------------------	---	----------------------------------	---	------------------------------	---------------	------------	--------------------------	--	---------------------------	------------------	------------------	--------------------------	---------------	---------------------------	-----------	---	-----------------	---------------	--

Caractéristiques techniques:

(selon CEI 60947-5-2)

Domaine de détection s_d	Cible normalisée	Reproductibilité (selon CEI 60947-5-2)	Reproductibilité ($T_A = \text{konstant}$)	Résolution	Tension de service U_B	Ondulation admissible	Tension de sortie à A1 $s = 0 \text{ mm}$ $s = 20 \text{ mm}$ $s = 40 \text{ mm}$	Charge à la sortie tension A1	Courant de sortie à A2 $s = 0 \text{ mm}$ $s = 40 \text{ mm}$	Charge max. à la sortie courant A2	Courant hors-charge	Bande passante	Retard à la disponibilité	Plage de température ambiante T_A : A1 chargé, sans charge sur A2 sans charge sur A1, A2 chargé	Dérive en température de s_r	Protection contre les courts-circuits	Protection contre les inversions	Chocs et vibrations	Longueur du câble	Poids (câble / connecteur)	Indice de protection	Protection CEM: CEI 60255-5 CEI 61000-4-2 CEI 61000-4-3 CEI 61000-4-4	Matériau du boîtier	Face sensible	Câble de raccordement (autres longueurs sur demande)
----------------------------	------------------	--	--	------------	--------------------------	-----------------------	---	-------------------------------	--	------------------------------------	---------------------	----------------	---------------------------	---	--------------------------------	---------------------------------------	----------------------------------	---------------------	-------------------	----------------------------	----------------------	---	---------------------	---------------	--

Technical data:

(according to IEC 60947-5-2)

Sensing range s_d	Standard target	Repeat accuracy (according to IEC 60947-5-2)	Repeat accuracy ($T_A = \text{constant}$)	Resolution	Supply voltage range U_B	Max. ripple content	Output voltage at A1 $s = 0 \text{ mm}$ $s = 20 \text{ mm}$ $s = 40 \text{ mm}$	Load at voltage output A1	Output current at A2 $s = 0 \text{ mm}$ $s = 40 \text{ mm}$	Max. load at current output A2	No-load supply current	Bandwidth	Time delay before availability	Ambient temperature range T_A : load at A1, no load at A2 no load at A1, load at A2	Temperature drift of s_r	Short-circuit protection	Voltage reversal protection	Shocks and vibration	Cable length	Weight (cable / connector)	Degree of protection	EMC protection: IEC 60255-5 IEC 61000-4-2 IEC 61000-4-3 IEC 61000-4-4	Housing material	Sensing face	Connection cable (other lengths on request)
---------------------	-----------------	--	---	------------	----------------------------	---------------------	---	---------------------------	--	--------------------------------	------------------------	-----------	--------------------------------	---	----------------------------	--------------------------	-----------------------------	----------------------	--------------	----------------------------	----------------------	---	------------------	--------------	---

0 ... 40 mm	120 x 120 x 1 mm	0,6 mm ($U_B = 20 \dots 30 \text{ VDC}$, $T_A = 23 \text{ °C} \pm 5 \text{ °C}$)	$\pm 0,1 \text{ mm}$	$\leq 10 \mu\text{m}$	15 ... 30 VDC	$\leq 20\% U_B$	0 V / - 0 + 0,4 V (23 °C) + 5,2 V / $\pm 0,4 \text{ V}$ (23 °C) + 10 V / $\pm 0,4 \text{ V}$ (23 °C)	$\leq 10 \text{ mA}$	4 mA / $\pm 0,8 \text{ mA}$ (23 °C) 20 mA / $\pm 0,8 \text{ mA}$ (23 °C)	0,5 k Ω ($U_B=15\text{V}$) / 1 k Ω ($U_B=30\text{V}$)	$\leq 12 \text{ mA}$	100 Hz (-3 dB bei/à/at $s=20 \text{ mm}$)	$\leq 50 \text{ msec}$	-25 ... +70°C	gemäss / selon / acc. to Fig. 2	$\leq 10\%$	eingebaut / intégrée / built-in	eingebaut / intégrée / built-in	IEC 60947-5-2 / 7.4	300 m max.	-390: 215/155 g, -320: 190/135g	IP 67	5 kV	Level 2	Level 3	Level 2	Messing cr/laiton cr/cr-plated brass	PBTP	PUR 4x0,25mm ² / 128x0,05mm \varnothing	2 m
-------------	------------------	--	----------------------	-----------------------	---------------	-----------------	--	----------------------	---	---	----------------------	--	------------------------	---------------	---------------------------------	-------------	---------------------------------	---------------------------------	---------------------	------------	---------------------------------	-------	------	---------	---------	---------	--------------------------------------	------	--	-----

Anschlusschema

Schéma de raccordement
Wiring diagram

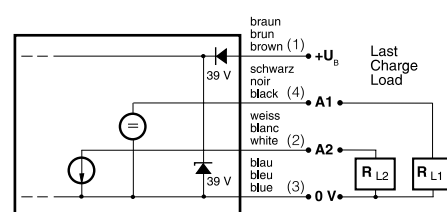

Steckerbelegung (Gerät)
Attribution des pins (appareil)
Pin assignment (device)

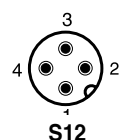

Abmessungen / Dimensions / Dimensions:

Diese Zeichnungen lassen sich aus dem Internet (www.contrinex.com) herunterladen.
 Ces dessins peuvent être téléchargés depuis Internet (www.contrinex.com).
 These drawings can be downloaded from Internet (www.contrinex.com).

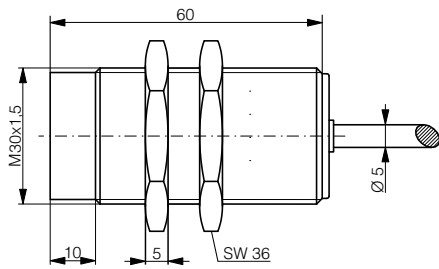

DW-AD-519-M30-390

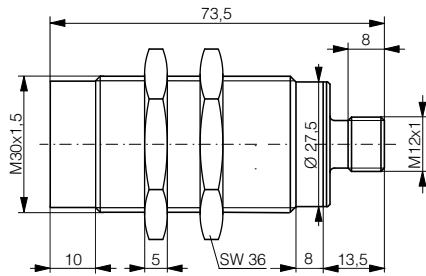

DW-AS-519-M30-390

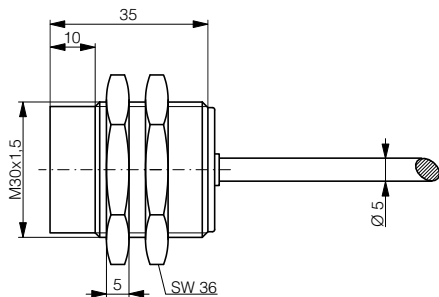

DW-AD-519-M30-320

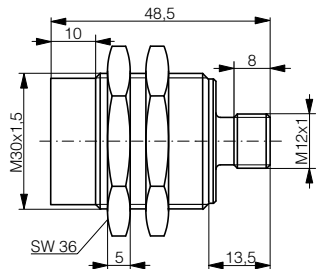

DW-AS-519-M30-320

* typische Werte / valeurs typiques / typical values

Ansprechkurve* / Courbe de réponse* / Response diagram*:

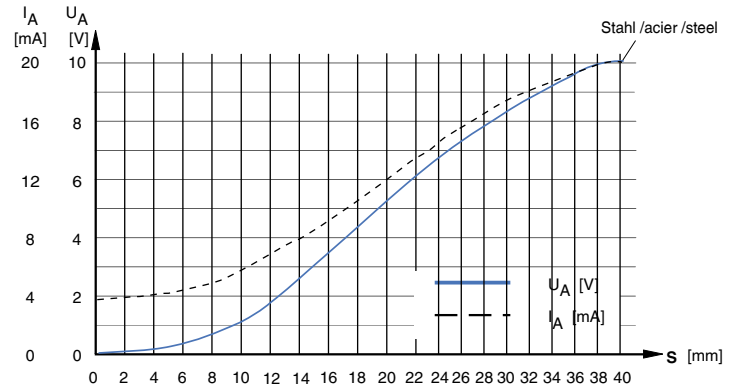

Fig. 2: Temperaturminderung / Réduction de température
 Temperature derating

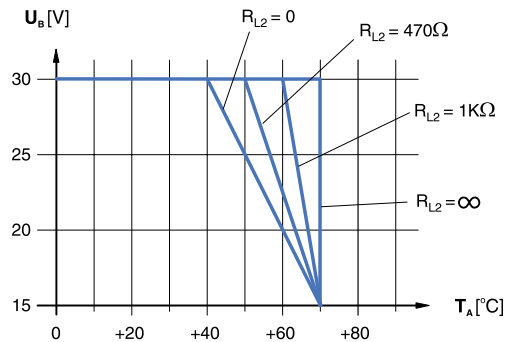
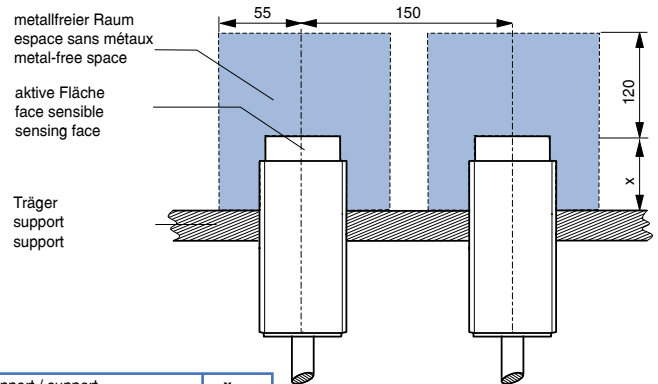

Fig. 3: Einbau / Montage / Installation



Träger / support / support	x
Aluminium / aluminium / aluminum	25 mm
Stahl / acier / steel	35 mm
Messing / laiton / brass	25 mm
Edelstahl / acier INOX / stainless steel	20 mm

Reduktionsfaktoren* / Coefficients de réduction* / Correction factors*

Stahl FE 360 Acier FE 360 Steel FE 360	1,0	Kupfer cuivre copper	0,4	Aluminium aluminium aluminum	0,4	Messing laiton brass	0,5	Edelstahl V2A acier INOX V2A stainless steel V2A	0,8
--	------------	----------------------------	------------	------------------------------------	------------	----------------------------	------------	--	------------

Typenspektrum / Types disponibles / Available types:

Artikelnummer Numéro article Part number	Typenbezeichnung désignation part reference	Anschluss raccordement connection	Ausgang sortie output
320 020 137	DW-AD-519-M30-390	Kabel / câble / cable	Spannung und Strom / tension et courant / voltage and current
320 020 138	DW-AS-519-M30-390	Stecker / connecteur / connector S12	Spannung und Strom / tension et courant / voltage and current
320 020 139	DW-AD-519-M30-320	Kabel / câble / cable	Spannung und Strom / tension et courant / voltage and current
320 020 147	DW-AS-519-M30-320	Stecker / connecteur / connector S12	Spannung und Strom / tension et courant / voltage and current

Der Einsatz dieser Geräte in Anwendungen, wo die **Sicherheit von Personen** von deren Funktion abhängt, ist **unzulässig**. Änderungen und Liefermöglichkeiten vorbehalten. Ces détecteurs **ne peuvent être utilisés** dans des applications où la **protection** ou la **sécurité de personnes** est concernée. Sous réserve de modifications et de possibilités de livraison. These proximity switches **must not be used** in applications where the **safety of people** is dependent on their functioning. Terms of delivery and rights to change design reserved.