

# TRANSISTOR MODULE

# QCA50AA100



UL;E76102 (M)

QCA50AA100 is a dual Darlington power transistor module which has series-connected high speed, high power Darlington transistors. Each transistor has a reverse paralleled fast recovery diode. The mounting base of the module is electrically isolated from semiconductor elements for simple heatsink construction,

- $I_C=50A$ ,  $V_{CEX}=1000V$
- Low saturation voltage for higher efficiency.
- High DC current gain  $h_{FE}$
- Isolated mounting base

### (Applications)

Motor Control (VVVF), AC/DC Servo, UPS,  
Switching Power Supply, Ultrasonic Application

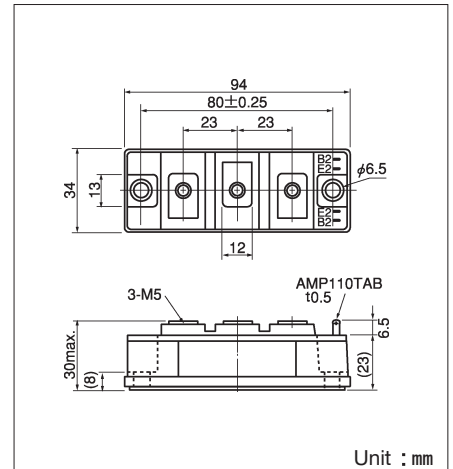
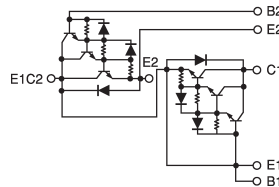

Unit : mm

### Maximum Ratings

( $T_j=25^\circ C$ )

Symbol	Item	Conditions	Ratings		
			QCA50AA100	Unit	
$V_{CBO}$	Collector-Base Voltage		1000	V	
$V_{CEX}$	Collector-Emitter Voltage	$V_{BE} = -2V$	1000	V	
$V_{EBO}$	Emitter-Base Voltage		7	V	
$I_C$	Collector Current		50	A	
$-I_C$	Reverse Collector Current		50	A	
$I_B$	Base Current		3	A	
$P_T$	Total power dissipation	$T_C=25^\circ C$	400	W	
$T_j$	Junction Temperature		-40~+150	$^\circ C$	
$T_{stg}$	Storage Temperature		-40~+125	$^\circ C$	
$V_{ISO}$	Isolation Voltage	A.C.1minute	2500	V	
	Mounting Torque	Mounting (M6)	Recommended Value 2.5~3.9 (25~40)	4.7 (48)	N·m (kgf·cm)
		Terminal (M5)	Recommended Value 1.5~2.5 (15~25)	2.7 (28)	
	Mass	Typical Value	210	g	

### Electrical Characteristics

( $T_j=25^\circ C$ )

Symbol	Item	Conditions	Ratings		Unit
			Min.	Max.	
$I_{CBO}$	Collector Cut-off Current	$V_{CB}=1000V$		1.0	mA
$I_{EBO}$	Emitter Cut-off Current	$V_{EB}=7V$		200	mA
$V_{CEX(SUS)}$	Collector Emitter Sustaining Voltage	$I_C=10A$ , $I_B=-3A$	1000		V
$h_{FE}$	DC Current Gain	$I_C=50A$ , $V_{CE}=2.8V$	75		
		$I_C=50A$ , $V_{CE}=5V$	100		
$V_{CE(sat)}$	Collector-Emitter Saturation Voltage	$I_C=50A$ , $I_B=1A$		2.5	V
$V_{BE(sat)}$	Base-Emitter Saturation Voltage	$I_C=50A$ , $I_B=1A$		3.5	V
$t_{on}$	Switching Time	On Time		2.5	$\mu s$
$t_s$		Storage Time	$V_{CC}=600V$ , $I_C=50A$ $I_{B1}=1A$ , $I_{B2}=-1A$	15.0	
$t_f$		Fall Time		3.0	
$V_{ECO}$	Collector-Emitter Reverse Voltage	$-I_C=50A$		1.8	V
$R_{th(j-c)}$	Thermal Impedance (junction to case)	Transistor part		0.31	$^\circ C/W$
		Diode part		1.2	

### D.C. Current Gain

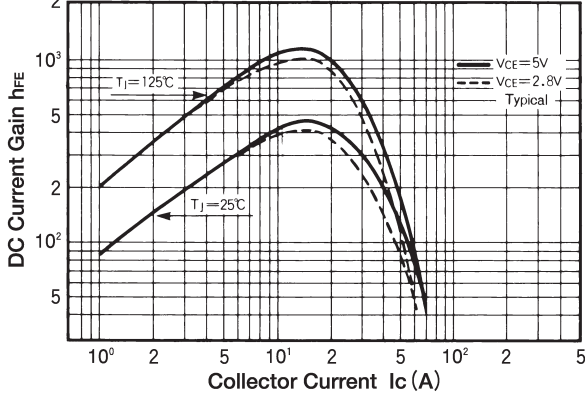

### Saturation Characteristics

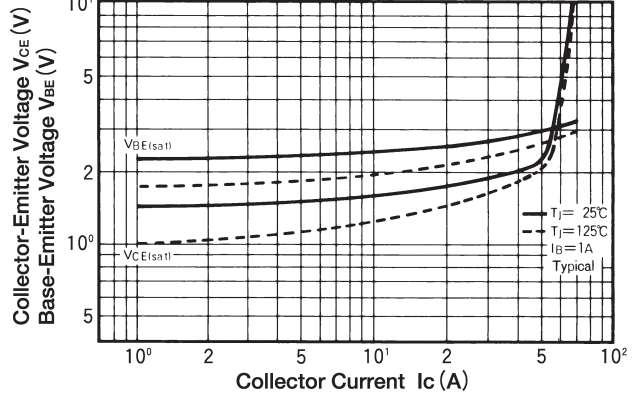

### Forward Bias Safe Operating Area

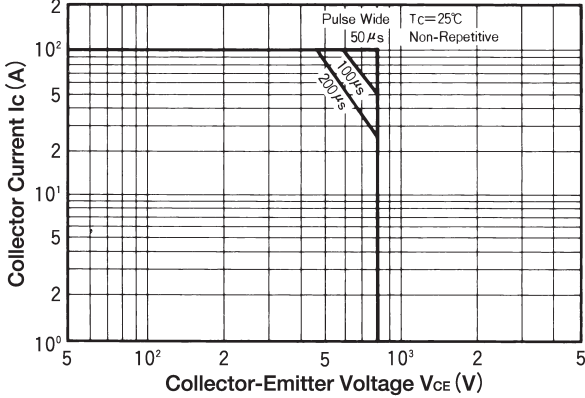

### Reverse Bias Safe Operating Area

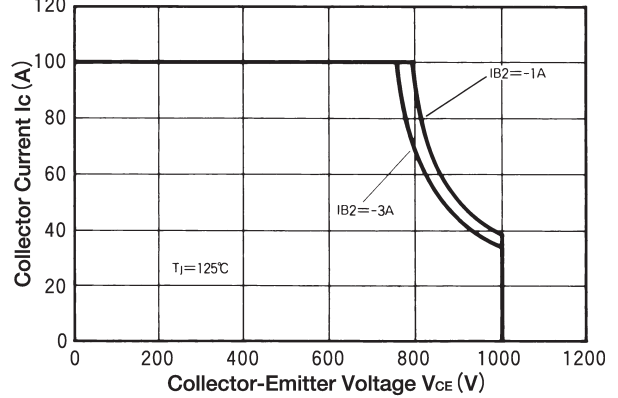

### Collector Current Derating Factor

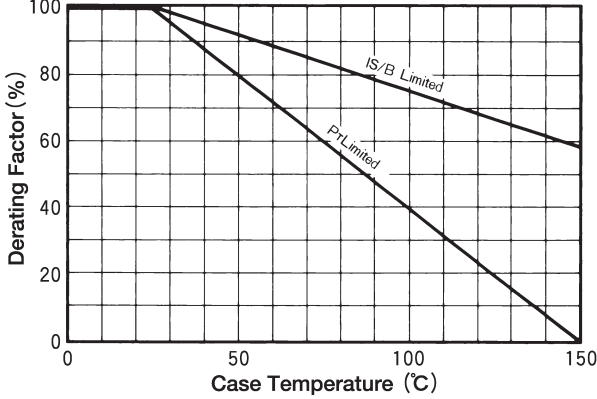

### Forward Voltage of Free Wheeling Diode

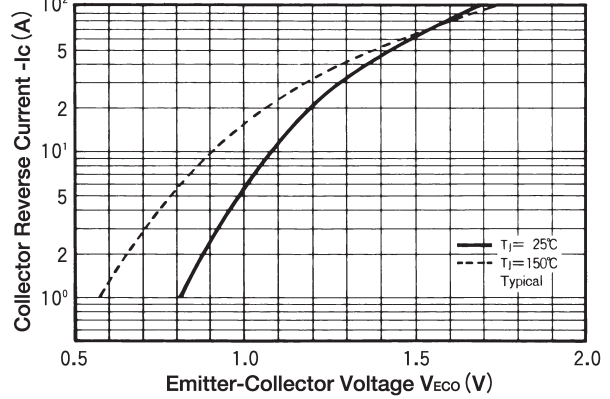

### Collector Current Vs Switching Time

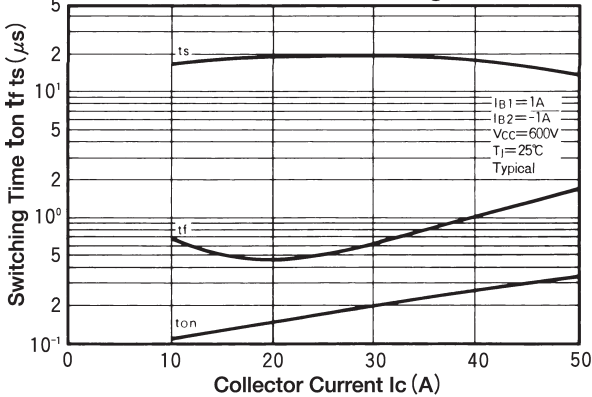

### Maximum Transient Thermal Impedance Characteristics

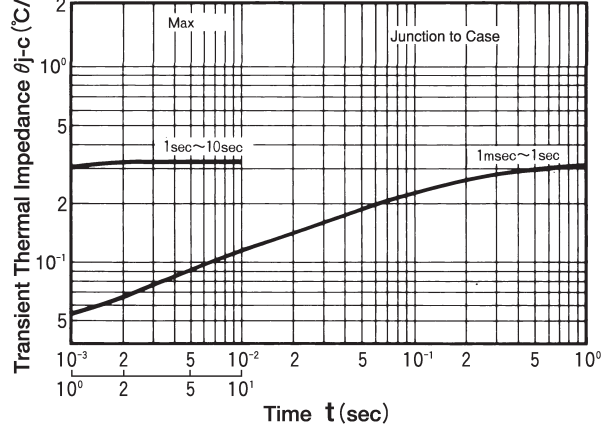

# TRANSISTOR MODULE

# QCA50AA120



UL;E76102 (M)

QCA50AA120 is a dual Darlington power transistor module which has series-connected high speed, high power Darlington transistors. Each transistor has a reverse paralleled fast recovery diode. The mounting base of the module is electrically isolated from semiconductor elements for simple heatsink construction,

- $I_C=50A$ ,  $V_{CEX}=1200V$
- Low saturation voltage for higher efficiency.
- High DC current gain  $h_{FE}$
- Isolated mounting base

**(Applications)**

Motor Control (VVVF), AC/DC Servo, UPS,  
Switching Power Supply, Ultrasonic Application

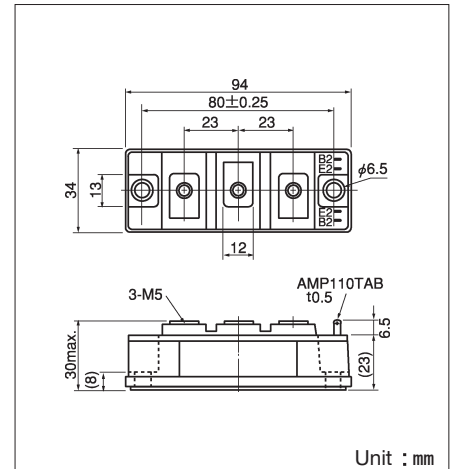
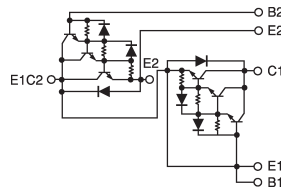

Unit : mm

**Maximum Ratings**

( $T_j=25^\circ C$ )

Symbol	Item	Conditions	Ratings		
			QCA50AA120	Unit	
$V_{CBO}$	Collector-Base Voltage		1200	V	
$V_{CEX}$	Collector-Emitter Voltage	$V_{BE} = -2V$	1200	V	
$V_{EBO}$	Emitter-Base Voltage		10	V	
$I_C$	Collector Current		50	A	
$-I_C$	Reverse Collector Current		50	A	
$I_B$	Base Current		3	A	
$P_T$	Total power dissipation	$T_C=25^\circ C$	400	W	
$T_j$	Junction Temperature		-40 ~ +150	$^\circ C$	
$T_{stg}$	Storage Temperature		-40 ~ +125	$^\circ C$	
$V_{ISO}$	Isolation Voltage	A.C.1minute	2500	V	
	Mounting Torque	Mounting (M6)	Recommended Value 2.5~3.9 (25~40)	4.7 (48)	N·m (kgf·cm)
		Terminal (M5)	Recommended Value 1.5~2.5 (15~25)	2.7 (28)	
	Mass	Typical Value	210	g	

**Electrical Characteristics**

( $T_j=25^\circ C$ )

Symbol	Item	Conditions	Ratings		Unit
			Min.	Max.	
$I_{CBO}$	Collector Cut-off Current	$V_{CB}=1200V$		1.0	mA
$I_{EBO}$	Emitter Cut-off Current	$V_{EB}=10V$		300	mA
$V_{CEX(SUS)}$	Collector Emitter Sustaning Voltage	$I_C=10A$ , $I_B=-2A$	1200		V
$h_{FE}$	DC Current Gain	$I_C=50A$ , $V_{CE}=5V$	75		
$V_{CE(sat)}$	Collector-Emitter Saturation Voltage	$I_C=50A$ , $I_B=1A$		3.0	V
$V_{BE(sat)}$	Base-Emitter Saturation Voltage	$I_C=50A$ , $I_B=1A$		3.5	V
$t_{on}$	Switching Time	On Time		2.5	$\mu s$
$t_s$		Storage Time	$V_{CC}=600V$ , $I_C=50A$ $I_{B1}=1A$ , $I_{B2}=-1A$	15.0	
$t_f$		Fall Time		3.0	
$V_{ECO}$	Collector-Emitter Reverse Voltage	$-I_C=50A$		1.8	V
$R_{th(j-c)}$	Thermal Impedance (junction to case)	Transistor part		0.31	$^\circ C/W$
		Diode part		1.2	

### D.C. Current Gain

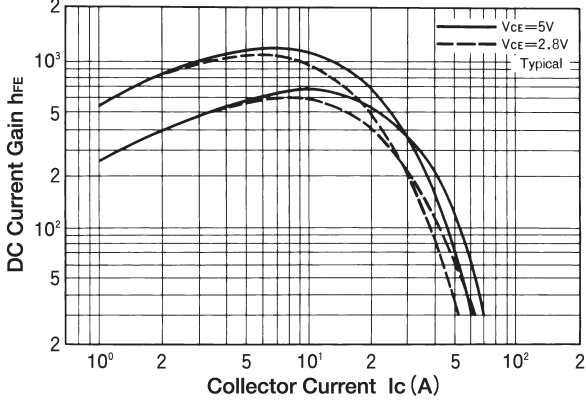

### Saturation Characteristics

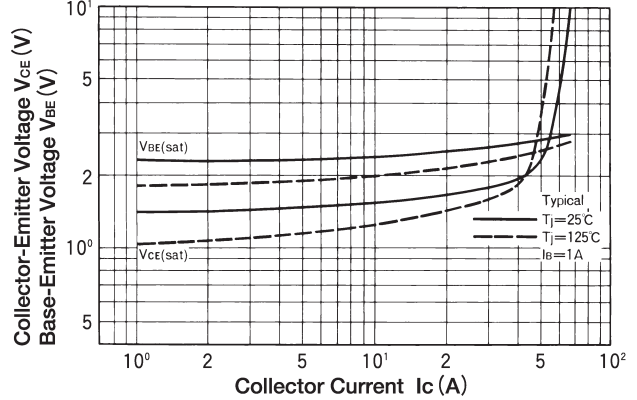

### Forward Bias Safe Operating Area

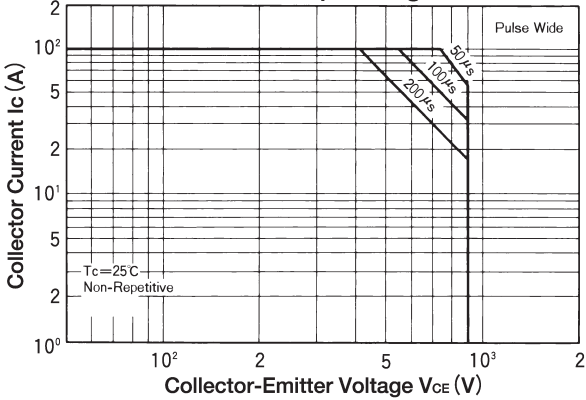

### Reverse Bias Safe Operating Area

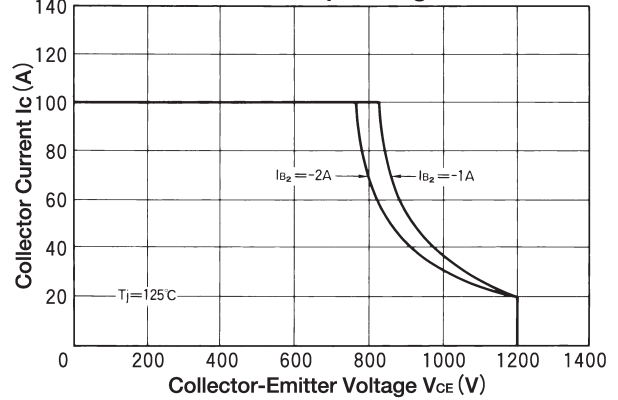

### Collector Current Derating Factor

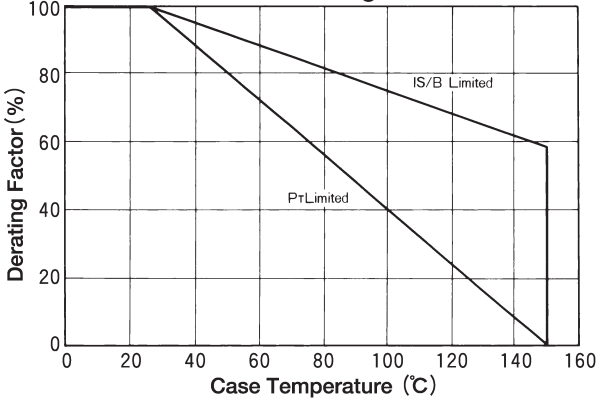

### Forward Voltage of Free Wheeling Diode

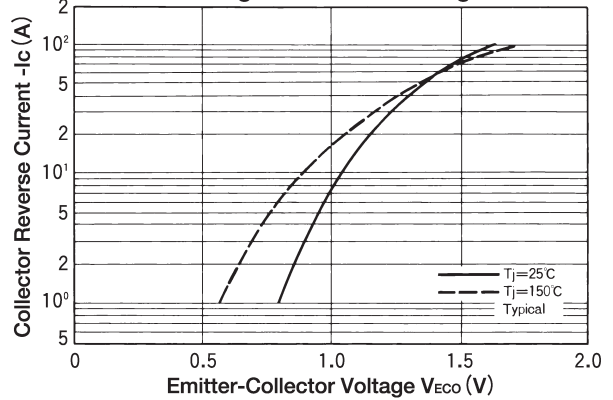

### Collector Current Vs Switching Time

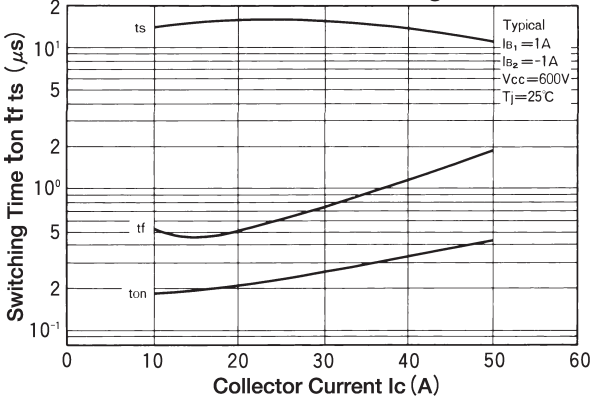

### Maximum Transient Thermal Impedance Characteristics

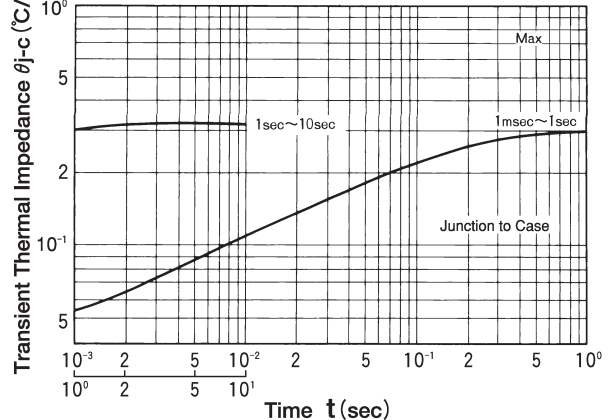

This datasheet has been downloaded from:

[www.DatasheetCatalog.com](http://www.DatasheetCatalog.com)

Datasheets for electronic components.